

WSD75-48S12 DC-DC Converters

Input 18V~75V, Output 12V/6.25A, Industry Standard Sixteenth-brick

Contents

Ordering Information 1
 Outline Diagram 2
 Specification 2
 Characteristic Curves 5
 Design Considerations 7
 Basic Connection 7
 Recommended Layout 8
 Input Voltage Range 8
 Output Voltage Adjust 8
 External Capacitance 9
 Remote Control 9
 Remote Sense 10
 Over Temperature Protection 10
 Output Over Voltage Protection 10
 Series and Parallel Operation 10
 Thermal Consideration 11
 Safety Consideration 11
 ESD Control 11
 Quality Statement 11
 Delivery Package Information 11
 Contact Information 12

Features

- ◆ **Industry Standard Sixteenth-brick**
 Without metal baseplate: 33.0×22.9×10.7mm
 With metal baseplate: 33.0×22.9×12.7mm
- ◆ **Rated Power 75W**
- ◆ **Ultra High Power Density:**
 11W/cm³ (Without metal baseplate)
 9.2W/cm³ (With metal baseplate)
- ◆ **Input Under Voltage Protection (14V to 18V turn off)**
- ◆ **Positive Logic Control (3.5V to 15.0V or floating turn on)**
- ◆ **Output Over Voltage Protection, auto-recovery (13.8V to 18V)**
- ◆ **Output Voltage Adjust Range: -20%~+10%V_{o,nom} of the rated output voltage**
- ◆ **Output Short-time Short-circuit Protection**
- ◆ **High Efficiency, 92% typ. (48V, full load)**
- ◆ **1500Vdc Isolation Voltage**
- ◆ **Operation Ambient Temperature: -40 °C to +85 °C**
Over Temperature Protection: 115 °C (Without metal baseplate) , 100 °C (With metal baseplate)
- ◆ **Applications: Telecom / Datacom system equipments, Railway & Rail transit ,Industrial control equipments and Instrument.**

DOSA Standard outline



Without metal baseplate



With metal baseplate



Ordering Information

See Contents for individual product ordering numbers.

Suffix	Description	Ordering No.
--	Shown as the specification	WSD75-48S12
P	Negative Logic Control: 3.5V~15V or floating, turn off; 0~0.5V, turn on	WSD75-48S12P
B	Positive Logic Control, With metal baseplate	WSD75-48S12B
PB	Negative Logic Control, With metal baseplate	WSD75-48S12PB

WSD75-48S12 DC-DC Converters

Input 18V~75V, Output 12V/6.25A, Industry Standard Sixteenth-brick

Outline Diagram

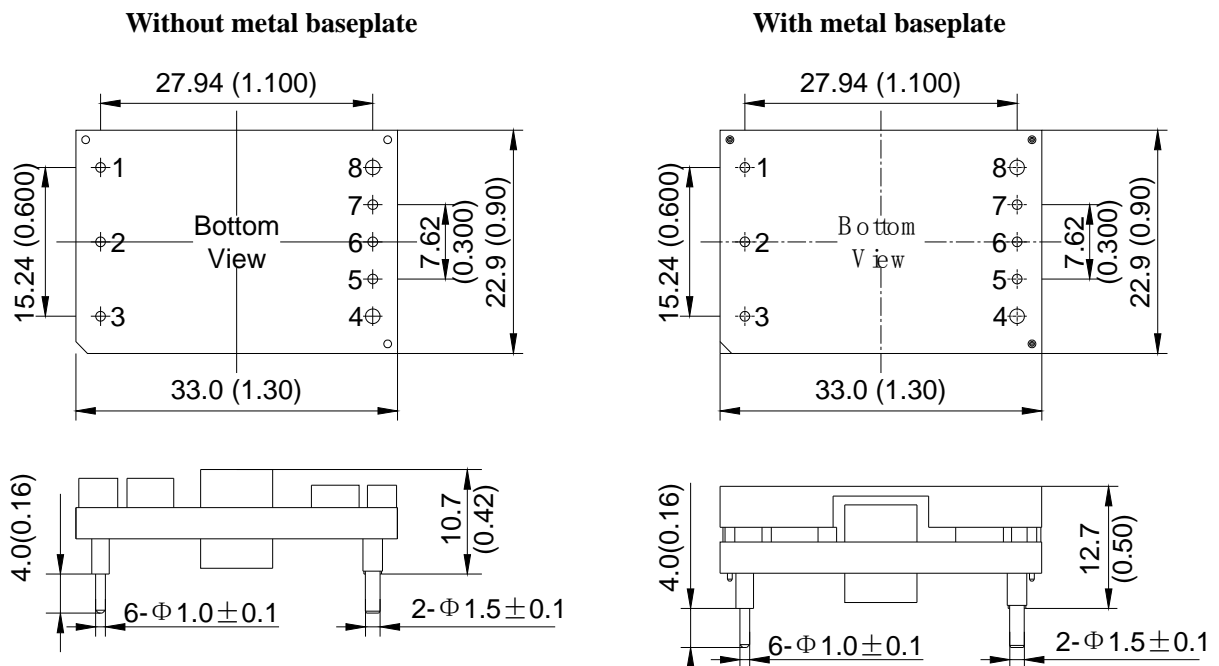

Pin definition:		
Pin	Symbol	Function
1	-Vin	Negative Input
2	CNT	Remote Control, turn on/off the converter. Output voltage on when CNT floating or high level applied
3	+Vin	Positive Input
4	+Vo	Positive Output
5	+S	Positive Remote Sense, connected to +Vo pin when not in use.
6	TRIM	Output Voltage Trim, voltage be trimmed up or down by applying external resistor connected to +S or -S output
7	-S	Negative Remote Sense, connected to -Vo pin if not used
8	-Vo	Negative Output

Notes: All dimensions in mm(inches) Tolerances: X.X±0.5(X.XX±0.02) X.XX±0.25(X.XXX±0.010)

Specification

Unless otherwise specified, all tests are at room temperature, standard atmosphere, pure resistive and load basic connection.

Input	Symbol	Min	Typ	Max	Unit	Conditions
Input Voltage	V _{in}	18	48	75	V	I _o :0~6.25A
Maximum transient input voltage	-	-	-	100	V	Transient < 100ms
Input Current	I _{in}	-	-	4.9	A	V _{in,min} , I _{o,max}
Positive Logic Control	On	-	3.5	-	15.0	V Refer to -V _{in} ; Turn on when CNT floating.
	Off	-	0	-	0.5	V Refer to -V _{in}

WSD75-48S12 DC-DC Converters

Input 18V~75V, Output 12V/6.25A, Industry Standard Sixteenth-brick

Negative Logic Control	On	-	0	-	0.5	V	Refer to $-V_{in}$
	Off	-	3.5	-	15.0	V	Refer to $-V_{in}$; Turn off when CNT floating.
Start-up Delay Time	T_{delay}	-	50	-	-	ms	—
Under Voltage Threshold	V_{UVLO}	14	-	18	-	V	—
Under Voltage Protection Hysteresis	ΔV_{UVLO}	1	-	3	-	V	—
Input reflected ripple current	-	-	50	100	-	mA	A 12 μ H/7A Inductor (20MHz) in series
No-load input current	-	-	75	150	-	mA	$V_{in,nom}$, $I_o=0A$
Standby input current	-	-	3	-	-	mA	—

Output	Symbol	Min	Typ	Max	Unit	Conditions	
Output Voltage	V_o	11.76	12.00	12.24	V	—	
Output Current	$I_{o,nom}$	-	-	6.25	A	$V_{in}: 18\sim 75V$	
Output Power	-	-	-	75	W	$V_{in}: 18\sim 75V$	
Output Voltage Adjust Range	V_{trim}	9.6	-	13.2	V	$I_o \leq 6.25A, P_o \leq 75W$	
Line Regulation	S_V	-	-	± 0.3	% V_o	$V_{in}: 18\sim 75V, I_{o,max}$	
Load Regulation	S_I	-	-	± 0.5	% V_o	$V_{in,nom}, I_o: 0\sim 6.25A$	
Output Over Voltage Protection Set Point	$V_{ov,set}$	13.2	-	18.0	V	$V_{in,nom}, P_o \leq 75W$ Hiccup mode	
Output Over Current Protection Range	$I_{o,lim}$	6.56	-	11.9	A	$V_{in}: 18\sim 75V, V_{o,nom}$	
Output Short-circuit Protection	short-time short-circuit protection, auto-recovery						
Peak to Peak Ripple and Noise	ΔV_{pp}	-	120	240	mV	20MHz bandwidth, a 47 μ F aluminum electrolytic capacitor and a 1 μ F ceramic capacitor are applied at output	
Rise Time	T_{rise}	-	25	-	ms	$V_{in,nom}, I_{o,max}$	
Capacitive Load	C_o	0	-	2000	μ F	pure resistive load	
Remote Sense Compensation Range	V_{sense}	0	-	0.6	V	+S and -S twisted Pair, length is less than 20cm	
Output Overshoot	V_{TO}	0	-	1.2	V	—	
Load Transient	Recovery Time	t_{tr}	-	-	300	μ s	25%~50%~25% $I_{o,nom}$ or 50%~75%~50% $I_{o,nom}$; 0.1A/ μ s
	Voltage Deviation	ΔV_{tr}	-	-	± 600	mV	

General	Symbol	Min	Typ	Max	Unit	Conditions	
Efficiency	η	-	90	92	%	$V_{in}=48V, I_{o,nom}$	
Isolation Resistance	Input ~ Output	R_{iso}	10	-	-	M Ω	—
	Input ~ substrate						
	Output ~ substrate						
Isolation Voltage	Input ~ Output	V_{iso}	1500	-	-	Vdc	—

WSD75-48S12 DC-DC Converters

Input 18V~75V, Output 12V/6.25A, Industry Standard Sixteenth-brick

	Input ~ substrate		1050	-	-		
	Output ~ substrate		500	-	-		
Switching frequency	—	250	300	350	kHz	—	
MTBF	-	-	2×10^6	-	h	BELLCORE TR-332	
Storage Temperature	-	-55	-	+125	°C	—	
Temperature Coefficient	S_T	-	± 0.1	± 0.02	%/°C	—	
Operating PCB Board Temperature	—	-40	-	+100	°C	Without metal baseplate, see derating curve 1	
Operating baseplate temperature	—	-40	-	+100	°C	With metal baseplate, see Derating curve 2	
Operating Ambient Temperature	—	-40	-	+85	°C	Without metal baseplate, see derating curves 3, 5; With metal baseplate, see derating curves 4, 6	
Thermal resistance See Derating curve 5 (Without metal baseplate).	$R_{\theta CA}$	—	14.7	—	°C/W	Natural convection	
	$R_{\theta CA}$	—	11.3	—	°C/W	100LFM convection	
	$R_{\theta CA}$	—	9	—	°C/W	200LFM convection	
	$R_{\theta CA}$	—	7.3	—	°C/W	300LFM convection	
	$R_{\theta CA}$	—	6.3	—	°C/W	400LFM convection	
Thermal resistance See derating curve 6 (With metal baseplate).	$R_{\theta CA}$	—	9.6	—	°C/W	Natural convection	
	$R_{\theta CA}$	—	7.8	—	°C/W	100LFM convection	
	$R_{\theta CA}$	—	6	—	°C/W	200LFM convection	
	$R_{\theta CA}$	—	5.1	—	°C/W	300LFM convection	
	$R_{\theta CA}$	—	4.3	—	°C/W	400LFM convection	
Over Temperature Protection Reference Point (Without metal baseplate)	T_{ref}	-	115	-	°C	See Over Temperature Protection consideration	
Over-temperature protection point (With metal baseplate).	T_{ref}	-	100	-	°C		
Over Temperature Protection Hysteresis	ΔT_{ref}	-	10	-	°C		
Vibration	Sine, Frequency: 10Hz-55Hz, Amplitude:0.35mm, 30 min in each of 3 perpendicular directions						
Shock	Half sine, peak acceleration:300m/s ² , duration:6 ms ; continuous 6 times of pulse in each of 3 perpendicular directions						
Hand Soldering	Maximum soldering Temperature < 425°C , and duration < 5s						
Wave Soldering	Maximum soldering Temperature < 255°C , and duration < 10s						
Weight	—	—	18	—	g	without heatsink	
	—	—	33	—	g	with heatsink	

WSD75-48S12 DC-DC Converters

Input 18V~75V, Output 12V/6.25A, Industry Standard Sixteenth-brick

Characteristic Curves

Load Transient Response1

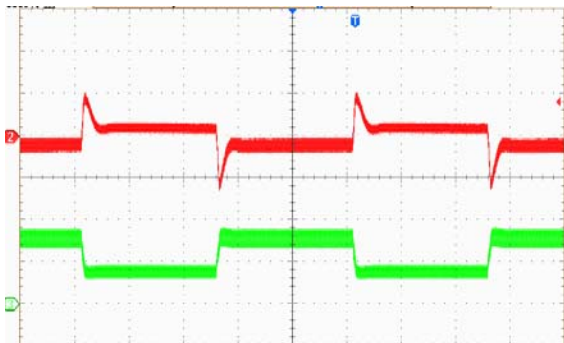

Load change: 25%~50%
 ~25% $I_{o,nom}$, 0.1A/ μ s
 V_{in} =48Vdc
 Trace1: 200mV/div
 Trace2: 2A/div
 Time scale: 400us /div

Load Transient Response2

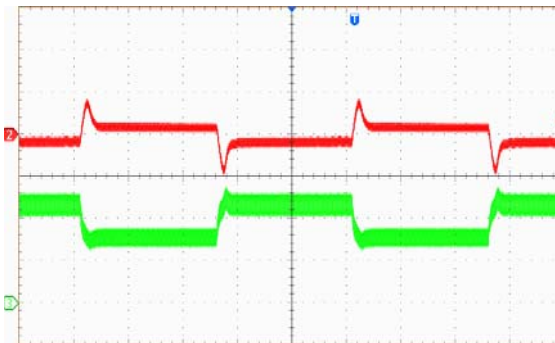

Load change: 50%~75%
 ~25% $I_{o,nom}$, 0.1A/ μ s
 V_{in} =48Vdc
 Trace1: 500mV/div
 Trace2: 2A/div
 Time scale: 400us /div

Output Ripple and noise

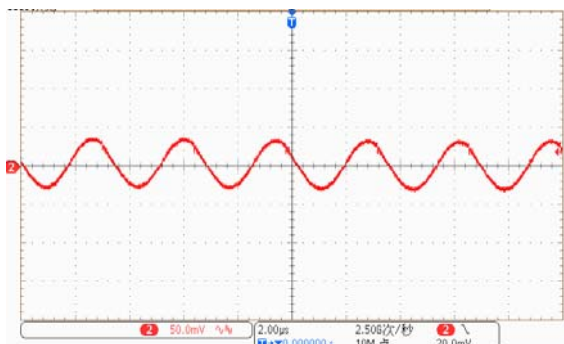

V_{in} =48V; I_o =6.25A

Start-up Delay Time

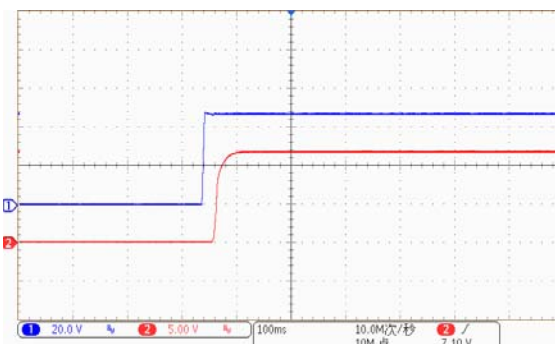

V_{in} =48V; I_o =6.25A

Rise Time

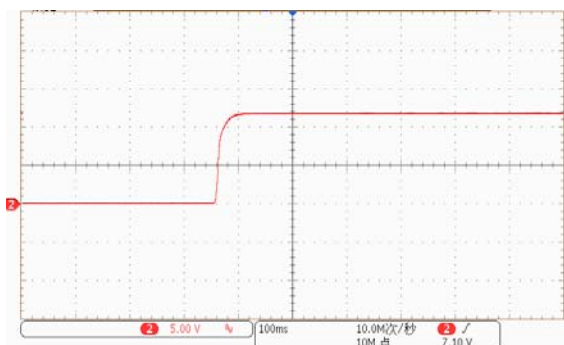

V_{in} =48V; I_o =6.25A

Turn-off



V_{in} =48V; I_o =6.25A

WSD75-48S12 DC-DC Converters

Input 18V~75V, Output 12V/6.25A, Industry Standard Sixteenth-brick

Derating Curve 1 (Without metal baseplate)

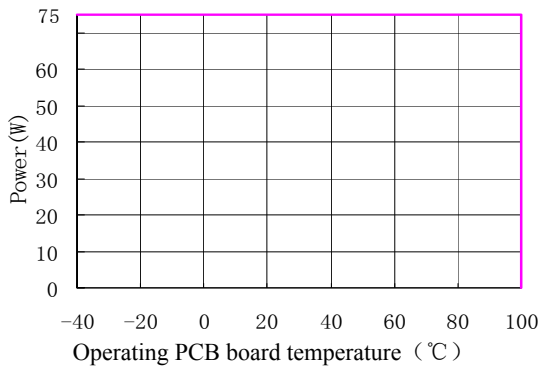

Derating Curve 2 (With metal baseplate)

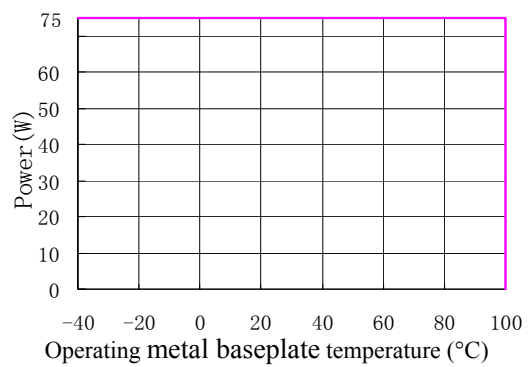

Derating Curve 3 (Without metal baseplate)

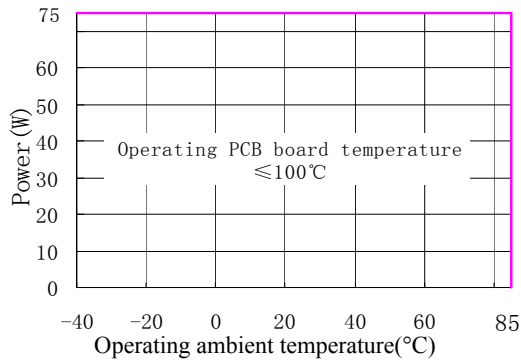

Derating Curve 4 (With metal baseplate)

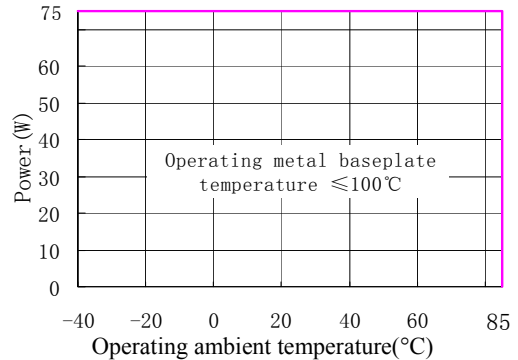

Derating Curve 5 (Without metal baseplate, Vin=48V)

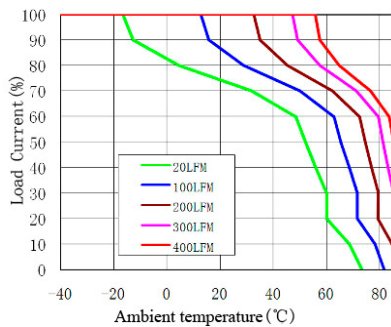

Note: 20LFM (free cooling) = 0.1m/s

Derating Curve 6 (With metal baseplate, Vin=48V)

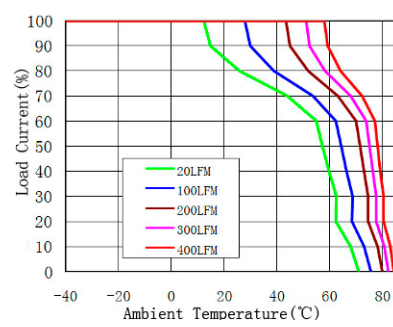

Note: 20LFM (free cooling) = 0.1m/s

Volt-ampere characteristic curve

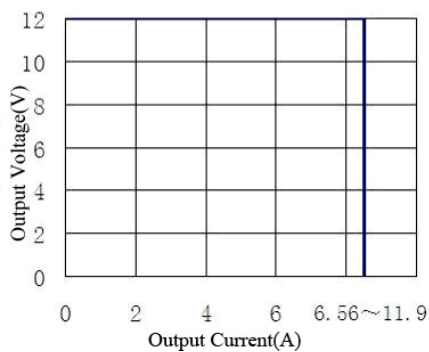

Typical efficiency curve

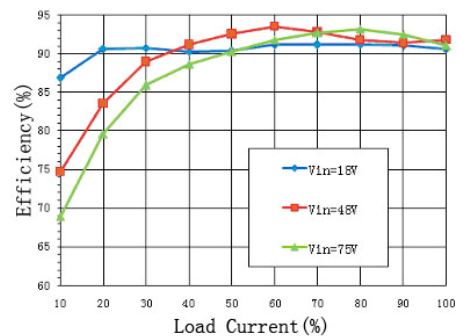

WSD75-48S12 DC-DC Converters

Input 18V~75V, Output 12V/6.25A, Industry Standard Sixteenth-brick

Concentrate:

1. When the product is installed, attention should be paid to the flow direction of hot air to ensure the smooth exchange of heat generated by loss and ambient temperature. It can be seen from the above derating curve 3 and derating curve 4 that as long as the PCB board temperature (Without metal baseplate) or the substrate temperature (With metal baseplate) does not exceed, the product can still work normally at full load within the required ambient temperature range (-40~85 °C). Under the condition of a certain ambient temperature, customers can improve the heat dissipation conditions by appropriately increasing the wind speed (Without metal baseplate or With metal baseplate) or further installing a heat sink on the heat dissipation 100°C substrate (With metal baseplate), thereby expanding the load capacity of derating curve 5 and derating curve 6.

2. Derating curves 5 and 6 are derating curves under different wind speeds of the non-heat dissipation substrate and the heat dissipation substrate (the pins are non-soldered mode). For customer thermal design reference, in actual use due to the application environment of the module, layout and wind speed and other factors are different. Please combine the actual use and give sufficient derating in the thermal design, which can not only effectively avoid the module from entering the over-temperature protection state, but also extend the service life of the module.

Design Considerations

Basic Connection

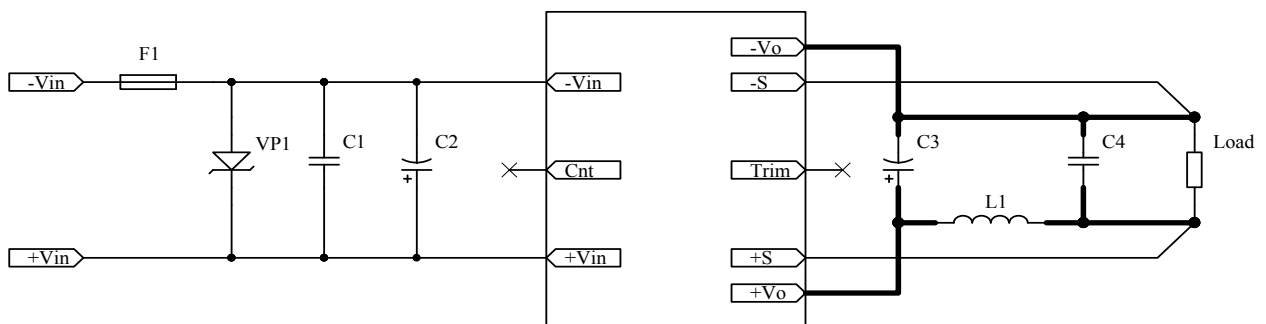

Notes: The basic connection indicates the basic requirements that the power module can provide rated output voltage and rated power only. Please refer the instruction followed for further information.

Parameter description:

Part No.	Components	Part No.	Components
F1	12~15A insurance	C3	-40°C electrolytic capacitor 100uF/25V
VP1	1.5KE75A	L1	0.22~0.33uH and ≥6.25A are recommended for applications that require lower ripple Note: The value in the performance parameters does not use this inductor
C1	Ceramic capacitor 2.2uF/100V Note: The capacitor is not used in the values in the performance parameters		
C2	-40°C electrolytic capacitor 100uF/100V	C4	47uF/25V ceramic capacitors

WSD75-48S12 DC-DC Converters

Input 18V~75V, Output 12V/6.25A, Industry Standard Sixteenth-brick

Recommended Layout

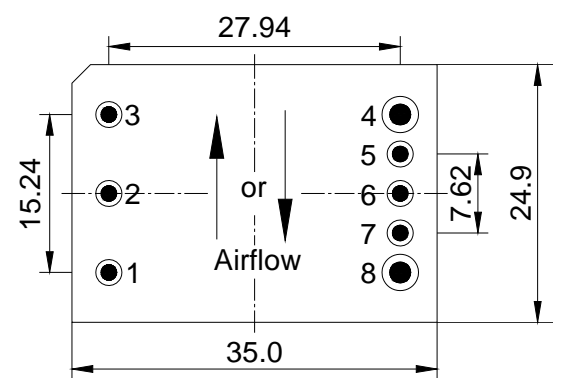

Printer board cloth board recommended schematic

NO.	Recommendation & Notes
Pad Design	The hole diameter of 4 and 8 pad shall be 2.0mm, and the diameter of pad shall be at least 3.5mm; The diameter of other pad holes shall be 1.5mm, and the diameter of pad shall be at least 2.5mm.
Airflow Direction	It is recommended to give priority to the upward or downward direction in the illustration on the left, and the wind speed can also be used when the vertical direction is shown.
Safety	This product is an isolated power module, pay attention to the input and output copper spacing.
Electrical	It is recommended that the coverage area of this product is the input or output ground (covering their respective areas), or DC electrical signals, and it is not recommended to lay sensitive signal lines or highly interference AC signals. Due to the large input and output currents, the current density of the trace connected to the input and output pins is recommended to be less than 7A/mm ² .

Input Voltage Range

The input voltage range of the converter is 18V to 75V. The continuous input voltage is not allowed to exceed 80V under any conditions, and exceeding the specified range will result in failure of the converter. It is recommended to connect a capacitance of 100μF or more at input to suppress the pulse spike from the input voltage. The input impedance of the converter looks like a negative resistor, which can interact with the reactance of the power bus (including any filter elements that have been added to the input of the converter), causing an unstable condition. Depending on the internal transformer's impedance, the external impedance should be required to have low source impedance. When source impedance of the power bus is high, the output voltage or ripple may be unstable.

The method to determine whether the impedance of the power bus is too high or not is to decrease the converter's input voltage from higher to lower gradually. If input lower voltage to the converter which works normally when the input voltage is high, then the output voltage of the converter can decrease or be unstable and it can return to normal after reducing the load current, it will be considered the impedance too large. The method for further confirmation is to connect a 100 uF/100V electrolytic capacitor to the module power pin in parallel after the module power is powered off (Individual cases may require a 2.2uF/100V ceramic capacitor to be connected between the electrolytic capacitor and the module pin), if the output getting better, it will be sure that the impedance is too large.

Output Voltage Adjust

The converters have an Output Voltage adjust pin (Trim). This pin can be used to adjust the output voltage above or below Output voltage initial setting. The maximum value of the trimmed up is 10%, even +S and -S pins are used to compensate the voltage simultaneously, the sum of the trimmed up and the compensation should not be more than 10%, or the characteristics will not be assured in compliant with the specification, even the over voltage protection may be triggered. The output power can not exceed 75W at increased output voltages, and the output current can not exceed 6.25A. When the trim pins are not used, they should be floated. External circuit is connected as the figure shown, the resistance is calculated as the formula below, please note

that the formula will be invalid when $R_{Trim-up}$ 、 $R_{Trim-down}$ are used simultaneously, users adjust the value based on the resistance applied.

WSD75-48S12 DC-DC Converters

Input 18V~75V, Output 12V/6.25A, Industry Standard Sixteenth-brick

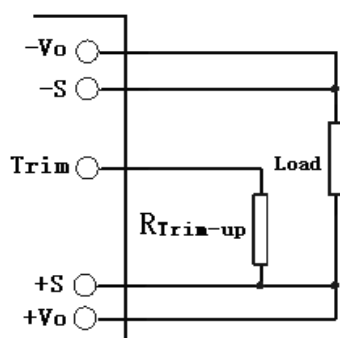

Connection of Trimming Up

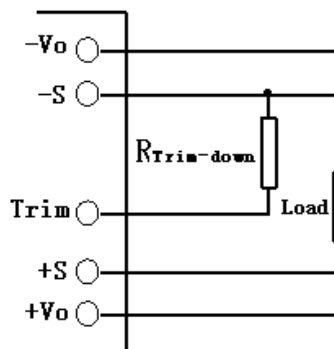

Connection for Trimming Down

Resistance for trimming up :
$$R_{Trim-up} = \left(\frac{5.11 \times Vo(100\% + \Delta(\%))}{1.225 \times \Delta(\%)} - \frac{5.11 \times 100(\%)}{\Delta(\%)} - 10.22 \right) (k\Omega)$$

Resistance for trimming down:
$$R_{Trim-down} = \left(\frac{5.11 \times 100(\%)}{\Delta(\%)} - 10.22 \right) (k\Omega)$$

Vo: rated output voltage, 12V;

$R_{Trim-up}$ 、 $R_{Trim-down}$: Resistance for trimming up or down, kΩ;

Δ (%): Change rate, divide output voltage by rated output voltage

For example, if the output voltage is 9.6V after adjusting 20% down, then Δ (%) = [(12-9.6)/12]×100% = 20%, which is brought into the equation

Down-regulation resistance: $5.11 \times 100\% / 20\% - 10.22 = 15.33$ (kΩ), you can actually take 15kΩ resistance;

If the output voltage is 13.2V after adjusting the output voltage by 10%, Δ (%) = [(13.2-12)/12]×100%=10%, which is brought into the formula

Up-regulation resistance: $[(5.11 \times 12(100\% + 10\%)) / 1.225 \times 10\%] - [(5.11 \times 100\%) / 10\%] - 10.22 = 489.3$ (kΩ), the actual 487kΩ resistor can be taken;

External Capacitance

Unless special purpose (i.e. prolonging hold-up time, input impedance matching), the recommended input filter's capacitance ranges 68μF~220μF, which not only offers a stable system, and reduces the cost, but also lessens the inrush current when the power supplies.

When larger capacitance is required, a circuit of suppressing the inrush current is recommended when the regulator start-up and a discharge circuit is recommended when the output dropped, ensuring the reliability and safety of other equipments in the system.

Remote Control

This function is obtained by applying the correct control level (or floating, high-impedance state) to the CNT pin. Positive logic remote control and negative logic remote control function is optional, WSD75-48S12 is a positive logic control product, when the applied level is 3.5~15V or floating when the module power output is on, when the applied level is 0~0.5V, the module power output is off. When the low level is applied, the external output current of the module CNT is less than 2mA, and the input current of the module CNT pin is less than 2mA when the high level (3.5~15V) is applied.

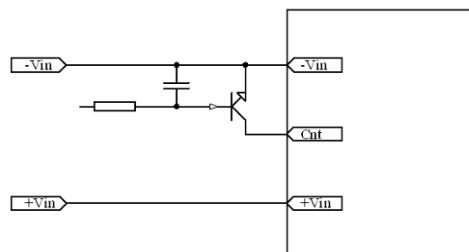

Temperature Reference Point A

Due to the logic comparator is semiconductor integrated chip with low resistance to surge, care should be taken to prevent CNT from surge, like application of TVS. When the pin is left floating, 1.25V~3.5V voltage appears on the pin.

WSD75-48S12P is provided with negative logic remote control. It has the same characteristic as

WSD75-48S12 DC-DC Converters**Input 18V~75V, Output 12V/6.25A, Industry Standard Sixteenth-brick**

WSD75-48S12, except control logic. When the level applied is less than 0.5V, the converter will be turned on, When the level is higher than 3.5V and less than 15V or be left floating, the converter will be off. Like positive logic control converters, care should be taken to prevent CNT from surge. When the pin is left floating, the voltage of the pin is 2.5V~12.5V.

In some applications, extra controls will be designed for the converter in user's PCB, such as output short circuit protection, over voltage protection, under voltage protection, synchronous control to the converter output voltage, and so on, remote control will give you help. The controls can be achieved by external circuit applied to the CNT pin.

When the signal from the system is beyond 3.5V~15V, or it can be enabled only within a very narrow control level, the aux circuit will be required. Please contact us for more information.

Remote Sense

The remote sense can be used to compensate for the voltage drop between the output pins of the converter and the load input pins by +S、-S pins. The +S and -S pins should be connected to the input pins of the load respectively. The remote sense circuit will compensate for up to 10% voltage drop between the sense voltage and the voltage at the output pins. If the remote sense is not needed, the -S should be connected to -Vout and +S should be connected to +Vout.

The anti-interference design should be considered when the +S、-S pins are connected to the pins to be compensated. The +S、-S traces should be located close to a ground trace or ground plane, and the area they surrounded should be minimized (just for electrical isolation); If cable connection presents, twisted pair wires should be used, EMI core are equipped with the twisted pair wires to reduce common mode noise when necessary, the sense leads should not be longer than 200mm, or the system characteristics may not be assured.

The sense leads only can carry very little current, and are not used for converter power output. Care should be taken in operation to avoid damaging the converter.

Over Temperature Protection

The converters are protected from thermal overload by an internal over temperature shutdown circuit. When the PCB temperature (reference point A, see the figure) exceeds the temperature trig point (110°C), the OTP circuit will cut down output power. The converter will stop until safe operating temperature is restored. Hysteresis temperature between OTP trig point and restart is approx 10°C. Time between OTP and restart is dependent on cooling of DC/DC converter.

Output Over Voltage Protection

The converter is designed with clamped over voltage protection, when output voltage exceeds 115% to 140% of the rated output voltage (the set point is between 115% to 140%, there is the difference based on the specific parameters, but not beyond the range), the output voltage will be clamped. If the output voltage returns to normal, the converter works normally.

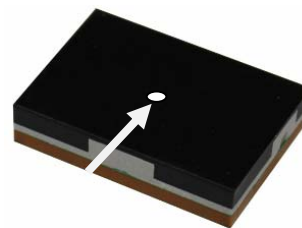
**Location of heatless substrate test points****Test point location with thermal baseplate****Series and Parallel Operation**

The converters should not be paralleled directly to increase power, but they can be paralleled each other through o-ring switches or diodes. Make sure that every converter's maximum load current should not exceed the rated current at anytime if they are paralleled without using external current sharing circuits.

The converters can operate in series. To prevent against start-up failure due to start up time difference, SBD with low voltage difference can be paralleled at the output pins (SBD negative terminal connect to the positive pin of the output) for each converter.

WSD75-48S12 DC-DC Converters**Input 18V~75V, Output 12V/6.25A, Industry Standard Sixteenth-brick****Thermal Consideration**

The power module can work at a variety of ambient temperatures, but ensuring adequate cooling can improve its working reliability and life, and the heat generated by the loss of the power module can be released by radiation, convection and conduction.

For example, (no heat dissipation substrate) how to select the minimum wind speed required, if the power module works at an ambient temperature of 80°C, $V_{in}=48V$, the output current is 4A, according to the above derating curve 5, the minimum wind speed required is about /s.2.0m

For example, (with heat dissipation substrate, without additional heat sink) how to select the required minimum wind speed, if the power module works at an ambient temperature of 50 °C, $V_{in}=48V$, the output current is 4A, according to the above derating curve 6, the minimum wind speed required is about 0.1m/s (natural wind).

Safety Consideration

The converter, as a component for the end user, should be installed into the equipment, and all the safety considerations are achieved under certain condition. It is required to meet safety requirements in system design. The converter output is considered SELV, and the expected input is considered TNV2, the primary to secondary is basic insulation to EN60950. The maximum operating temperature for PCB is 150 °C.

To avoid fire and be protected when short circuit occurred, it is recommended that a fast blow fuse with rating 2.5 to 3 times of converter's continuous input peak current is used at the input terminal.

ESD Control

The converters are processed and manufactured in an ESD controlled environment and supplied in conductive packaging to prevent ESD damage from occurring before or during shipping. It is essential that they are unpacked and handled using an ESD control procedures. Failure to do so affects the lifetime of the converter.

Quality Statement

The converters are manufactured in accordance with ISO 9001 system requirements, and are monitored 100% by auto-testing system, 100% burn in.

The warranty for the converters is 5-year.

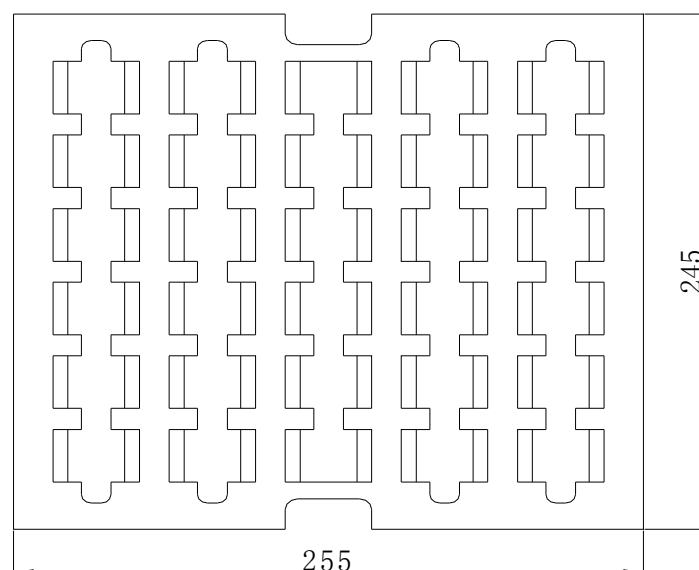
Delivery Package Information

WSD75-48S12 DC-DC ConvertersInput 18V~75V, Output 12V/6.25A, Industry Standard Sixteenth-brick

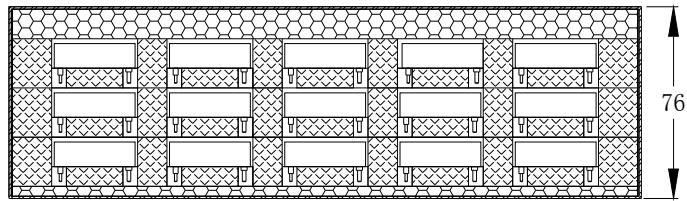

Package material is multiple wall corrugated, internal material is anti-static foam, it's surface resistance is from $10^5 \Omega$ to $10^{12} \Omega$.

Substrate module without heat dissipation: small package is $3 \times 30 = 90$ pieces per box, weighing about 1.8kg; $4 \times 90 = 360$ pieces per large package, weighing about 8.0kg. Module with heat dissipation substrate: small package for $3 \times 30 = 90$ pieces per box, weight about 3.15kg; $4 \times 90 = 360$ pieces per large package, weighing about 13.5kg.

Contact Information

Anhui Hesion Trading Co., Ltd.
& Beijing Yihongtai Technology Dev. Co., Ltd

TEL: +86-551-65369069, 65369067

Email: alecz@ahhesion.com

Backup: alecz@126.com

www.ahhesionpower.com